

CUSTOMER SERVICE

If you are missing parts or have any questions about this product, contact our customer service representative first!



CALL 1-800-295-1980

You can also order parts by writing to the address listed below. Please include the product model number, color and a detailed description of the part.

Customer Service Department No. 413
12345 Albert-Hudon Boulevard, Suite 100
Montreal, Quebec
Canada H1G 3L1

E-MAIL: csr@jardcoent.com

**WARNING**

- * Failure to follow these warnings and assembly instructions could result in serious injury or death.
- * Read all instructions before assembling crib. **KEEP INSTRUCTIONS FOR FUTURE USE.**
- * Before each usage or assembly, inspect crib for damaged hardware, loose joints, missing parts or sharp edges, **DO NOT** use crib if any parts are missing or broken. Ask your dealer or write to our customer service representative (address & phone number shown above) for replacement parts and instructional literature if needed. **DO NOT** substitute parts.
- * Infants can suffocate on soft bedding. Never add a pillow or comforter. Never place additional padding under an infant.
- * When child is able to climb out or reaches the height of 35 inches (90 cm), the crib shall no longer be used.
- * To reduce the risk of SIDS, pediatricians recommend healthy infants be placed on their backs to sleep, unless otherwise advised by your physician.
- * **DO NOT** place crib near window where cords from blinds or drapes may strangle a child.
- * Strings can cause strangulation! **DO NOT** place crib with a string around a child's neck, such as hood strings or pacifier cords. **DO NOT** suspend strings over a crib or attach strings to toys.
- * To help prevent strangulation tighten all fasteners. A child can trap parts of the body or clothing on loose fasteners.
- * If refinishing, use a non-toxic finish specified for children's products.
- * When child is able to pull to standing position, set mattress to lowest position and remove bumper pads, large toys and other objects that could serve as steps for climbing out.
- * Never use plastic shipping bags or other plastic film as mattress covers because they can cause suffocation.
- * **DO NOT** use a water mattress with this crib.
- * Replace teething rail if damaged or loose (if teething rail is provided for this model).
- * **CAUTION: ANY MATTRESS USED IN THIS CRIB MUST BE AT LEAST 27-1/4 INCHES BY 51-5/8 INCHES (69CM BY 131CM) WITH A MINIMUM THICKNESS OF 4 INCHES (10CM) BUT NOT EXCEEDING 6 INCHES (15CM).**
- * Infants can suffocate in gaps between crib sides and a mattress that is too small.
- * Follow warnings on all products in a crib.

**WARNING ENTRAPMENT / STRANGULATION HAZARD:**

- * Infants have died in toddler beds from entrapment and strangulation.
- * **NEVER** use bed with children under 15 months.
- * **NEVER** place bed near windows where cords from blinds or drapes may strangle a child.
- * The **TODDLER BED** or **DAY BED** is not intended for children under 15 months of age or over 50
- * If guardrails are used as the mattress containment means, guardrail(s) provided must be used to avoid the formation of a gap between the mattress and the bed that could cause an entrapment (when product is used as a **TODDLER BED** or **DAY BED**).
- * **DO NOT** place **DAY BED** or **TODDLER BED** near windows where cords from blinds or drapes may strangle a child.
- * **DO NOT** place items with a string, cord, or ribbon around a child's neck, such as hood strings or pacifier cords.
- * **DO NOT** suspend strings over a **TODDLER BED** or **DAY BED** for any reason.

NOTES

- * Ensure all parts and components are present before beginning assembly.
- * Assemble on soft, smooth surface to prevent damage to product finish.
- * Phillips head screw driver is not included.
- * DO NOT use power tools.
- * CAUTION: Adult assembly required.
- * Assembly will require two people.



WARNING: Should this product become damaged, and/or components are broken or missing, DO NOT USE.

CARE AND CLEANING

Dust regularly with a soft, lint-free cloth to prevent soil build-up. A damp cloth may be used occasionally to clean surface. Dry immediately. Do not use any abrasives that may damage finish. Excessive exposure to sunlight and extreme changes in temperature and moisture can damage wood furniture.

If the crib is to be stored, store in cool dry place and carefully package all original hardware to protect from loss.

MAINTENANCE

Check bolts/screws periodically and tighten them if necessary.











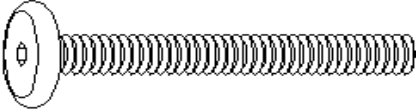
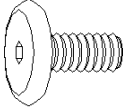

LIMITED WARRANTY

Jardine Enterprise warrants its product to be free from defects in material and workmanship and agrees to remedy any such defect. This warranty covers 1 year from the date of original purchase. This warranty is valid only upon presentation of proof of purchase. This is solely limited to the repair or replacement of defective furniture components and no assembly labor is included. This warranty does not apply to any product which has been improperly assembled, subjected to misuse or abuse or which has been altered or repaired in any way. This warranty gives you specific legal rights and you may also have other rights which vary from State to State.

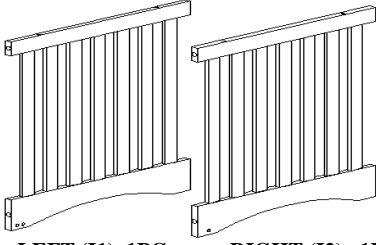
ASSEMBLY INSTRUCTION FOR "343-8359" CRIB

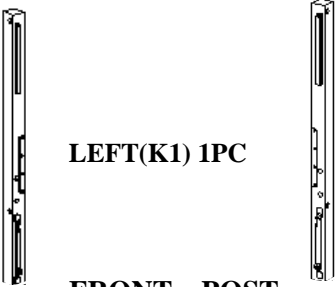
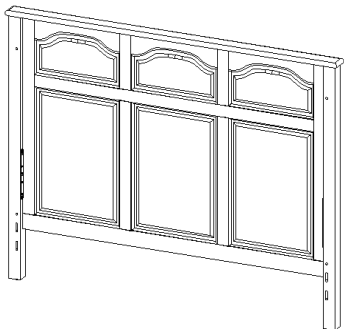
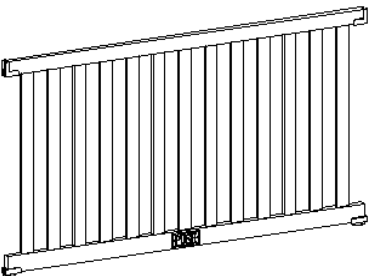
DA626BC (Honey Pine) & DA627BC (White)

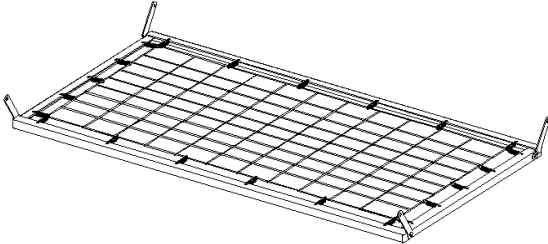
HARDWARE AND PART LIST

<p>A </p> <p style="text-align: center;">BOLT 3-1/2"×1/4"DIA 12PCS</p>	<p>B </p> <p style="text-align: center;">BOLT 2-1/4"×1/4"DIA 4PCS</p>
<p>C </p> <p style="text-align: center;">BOLT 2"×1/4"DIA 2PCS</p>	<p>D </p> <p style="text-align: center;">1/2"×1/4"DIA MATTRESS SUPPORT BOLT 16PCS</p>
<p>E </p> <p style="text-align: center;">RUBBER BUMPER 2PCS</p>	<p>F </p> <p style="text-align: center;">0.3805"×0.1785"DIA MACHINE SCREWS 2PCS</p>
<p>G </p> <p style="text-align: center;">SMALL ALLEN WRENCH 4MM 1PC</p>	<p>H LEFT(H1) 1PC RIGHT(H2) 1PC</p>  <p style="text-align: center;">TOP PANEL</p>
<p>I </p> <p style="text-align: center;">LEFT (I1) 1PC RIGHT (I2) 1PC SIDE PANEL</p>	<p>J </p> <p style="text-align: center;">BUN FOOT 4PCS</p> <p>K </p> <p style="text-align: center;">LEFT(K1) 1PC RIGHT(K2) 1PC FRONT POST</p>
<p>L </p> <p style="text-align: center;">HEAD BOARD 1PC</p>	<p>M </p> <p style="text-align: center;">DROP SIDE 1PC</p>
<p>N </p> <p style="text-align: center;">GUARD RAIL 1PC</p>	<p>P </p> <p style="text-align: center;">MATTRESS SUPPORT 1PC</p>
<p>O </p> <p style="text-align: center;">STABLIZING BAR 1PC</p>	

ASSEMBLY INSTRUCTION FOR "343-8359" CRIB

DA626BC (Honey Pine) & DA627BC (White)

Thank you for purchasing this quality product. Be sure to check all packing material carefully for small parts, which may have some loose inside the carton during shipment. Identify and count all parts and compare with the parts list below.

NOTE: WHEN INSERTING SCREWS TURN CLOCKWISE UNTIL TIGHT, THEN LOOSEN 1/2-3/4 OF A TURN, AFTER CRIB IS COMPLETELY ASSEMBLED, RETURN TO EACH SCREW AND TIGHTEN, USE WAX OR SOAP ON ALL SCREWS TO FACILITATE ASSEMBLY.

STEP 1.

SCREW THE BUN FOOT (PART J) INTO THE FRONT POST (PART K1 AND K2), ATTACH THE RIGHT FRONT POST (PART K2) TO THE RIGHT SIDE FRAME (PART I2) USING 2 BOLTS (PART A) AND WRENCH (PART G) PROVIDED, REPEAT THIS STEP FOR THE LEFT FRONT POST (PART K1) AND LEFT SIDE FRAME (PART I1).

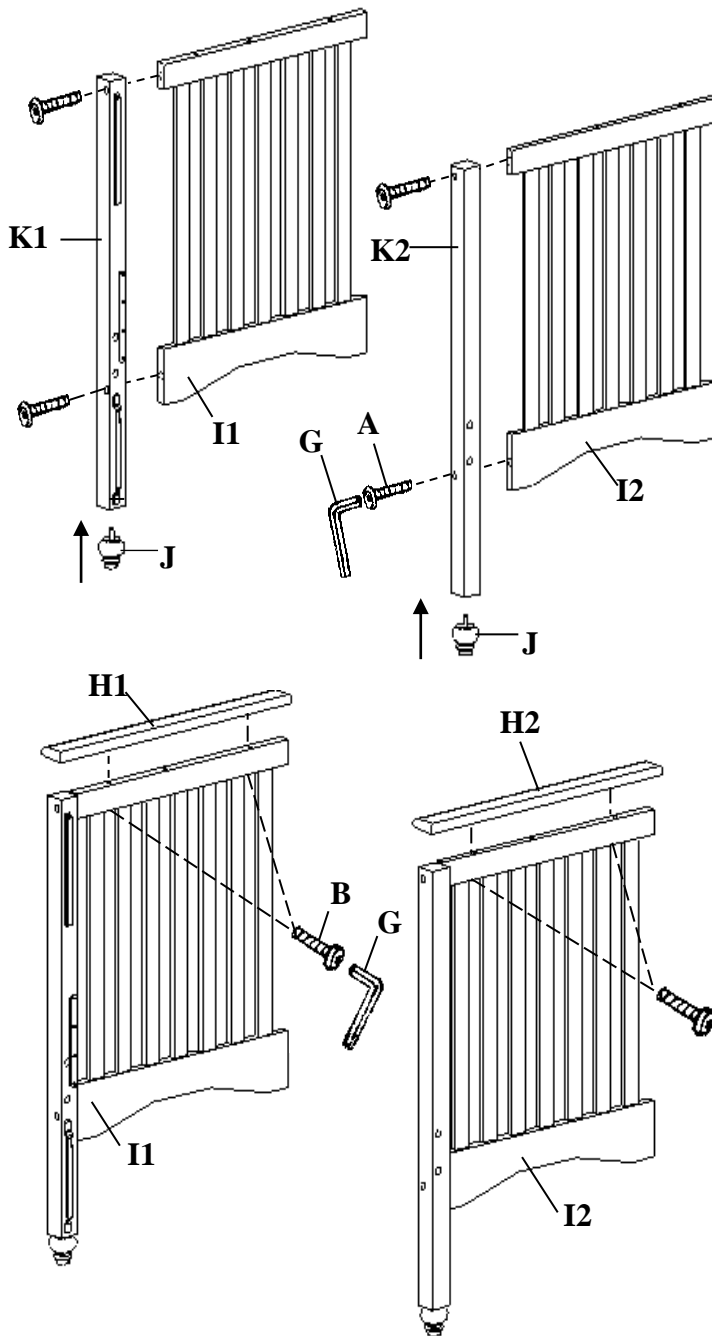

STEP 2.

ATTACH THE TOP RIGHT PANEL (PART H2) TO THE RIGHT SIDE FRAME USING BOLTS (PART B) AND WRENCH (PART G) PROVIDED. REPEAT THIS STEP FOR THE TOP LEFT PANEL (PART H1) AND THE LEFT SIDE FRAME (PART I1).

ASSEMBLY INSTRUCTION FOR "343-8359" CRIB

DA626BC (Honey Pine) & DA627BC (White)

STEP. 3

SCREW THE BUN FOOT (PART J) INTO POSTS OF HEADBOARD (PART L). ATTACH THE LEFT SIDE FRAME ASSEMBLY (I1 & K1) ONTO THE HEADBOARD (PART L). USING 2 BOLTS (PART A) AND WRENCH PROVIDED (PART G). REPEAT THIS STEP TO ASSEMBLE RIGHT SIDE ASSEMBLY (I2 & K2). TO ATTACH PART (O) TO PARTS(I), INSERT HARDWARE(C) INTO PARTS(I) TO LOCK PART(O) IN PLACE BY USING HARDWARE(G).

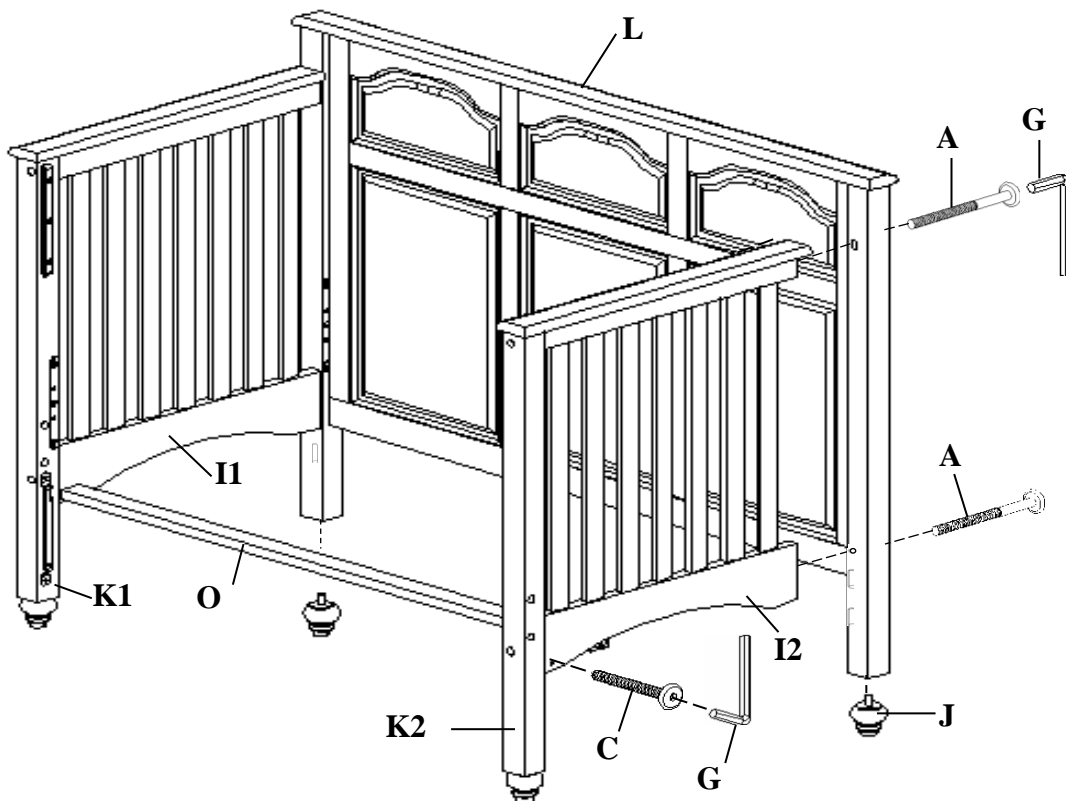

ASSEMBLY INSTRUCTION FOR "343-8359" CRIB

DA626BC (Honey Pine) & DA627BC (White)

STEP 4:

Attach the mattress support to the 4 corner posts with the mattress support bolts (D). Use Allen Key to tighten bolts. Refer to details 1 and 2 for direction on how to properly attach the mattress support.

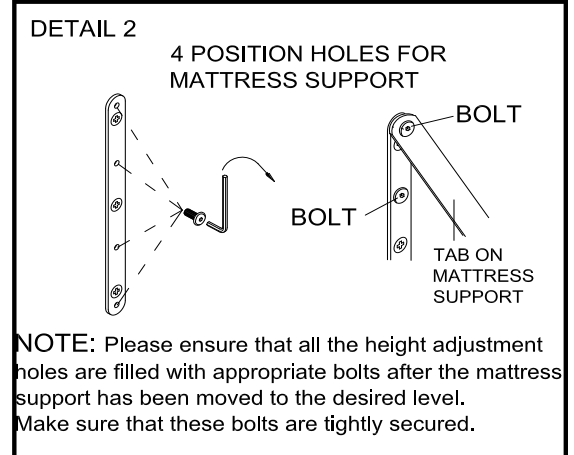
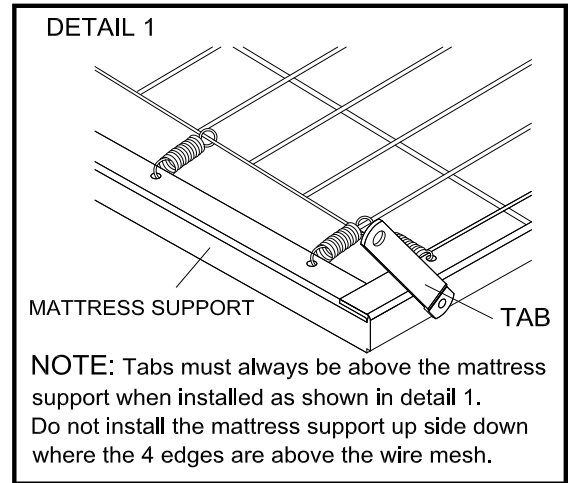
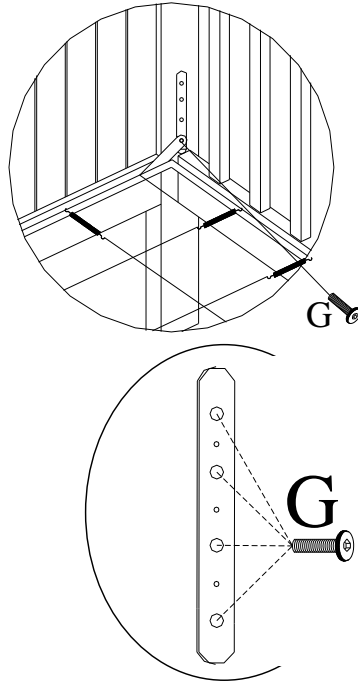
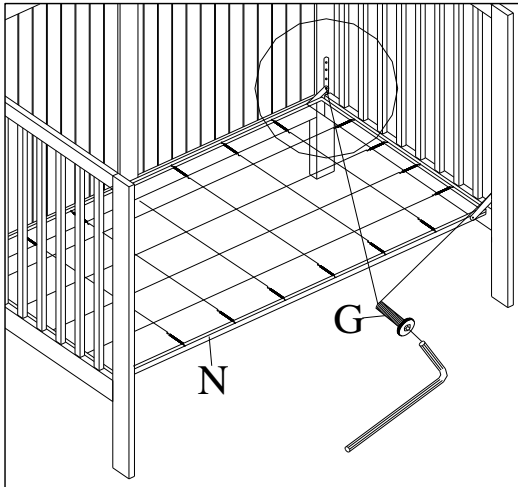

INCORRECT-
Raised edge should face down -this photo shows mattress support is upside down



INCORRECT-
Tabs on corners of mattress support should point up

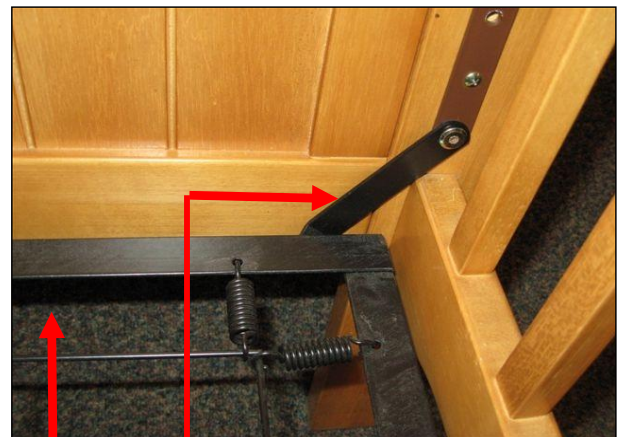

CORRECT

* Tabs to point UP.

* Flat surface of mattress support to face up - mattress must sit on flat surface.

ASSEMBLY INSTRUCTION FOR "343-8359" CRIB

DA626BC (Honey Pine) & DA627BC (White)

STEP 5

ALIGN AND SLIDE DROP SIDE FROM THE BOTTOM ONTO THE DROP SIDE UPPER AND LOWER TRACKS ON THE LEFT AND RIGHT FRONT POSTS. MAKE SURE THE RELEASE LATCH ON THE LOWER GUIDES IS TO THE OUTSIDE OF THE LOWER DROP SIDE TRACKS (PULL TOWARDS YOU). RAISE DROPSIDE UNTIL IT IS LOCKED INTO PLACE.

CAUTION: DO NOT FORCE THE DROP SIDE AS YOU MAY BREAK THE LOCKS, GUIDES, OR TRACKS.

ATTACH RUBBER STOPPERS BEFORE OPERATING DROP SIDE.

Note: When moving the crib, DO NOT hold it by the drop side, always use the side frames to move the crib. WHEN ASSEMBLING THE DROP SIDE, MAKE SURE THE TEETHING RAIL IS ON THE TOP.

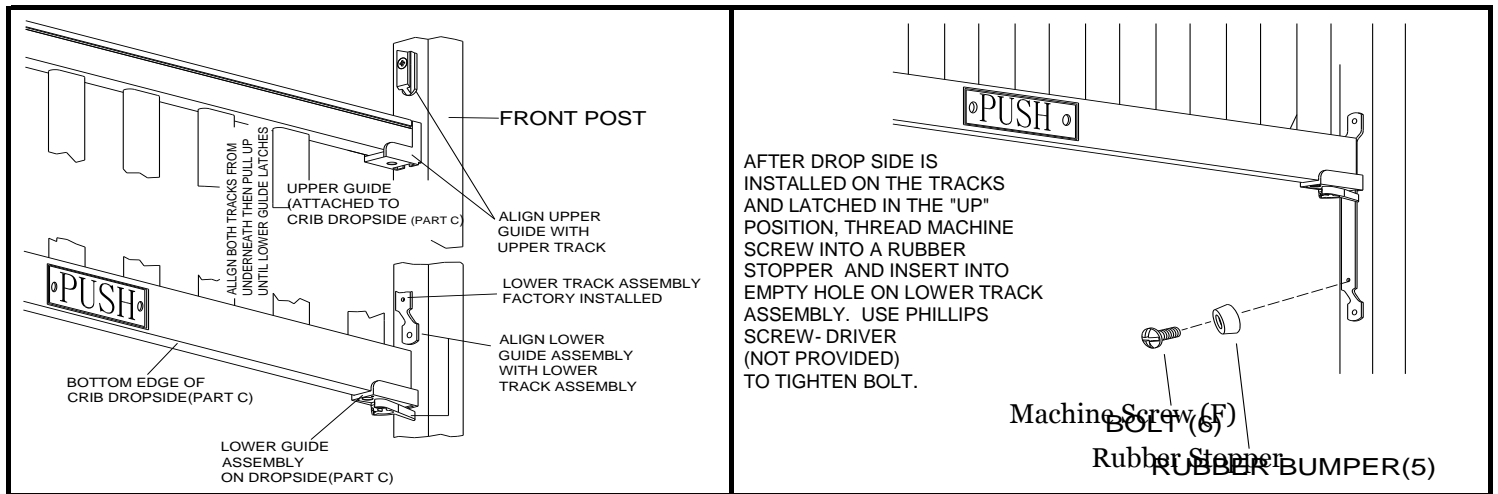

PHOTO A

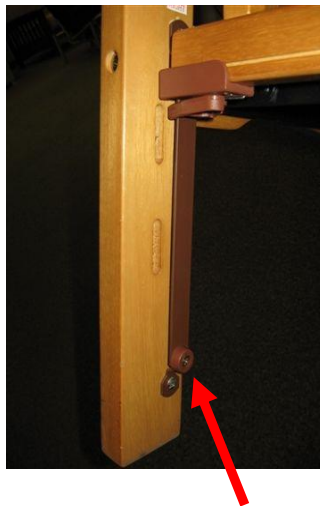
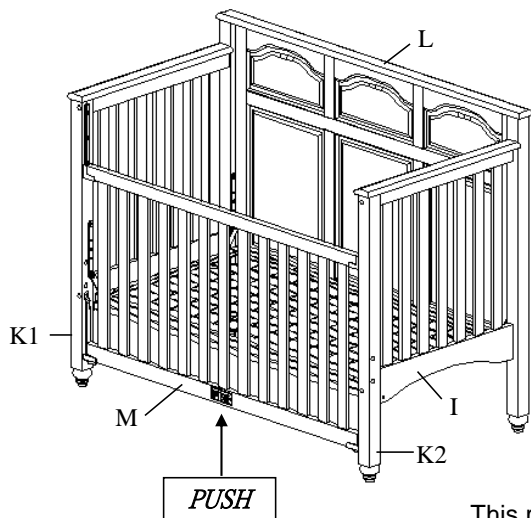

PHOTO B



The release latch on the lower guides must be on the outside of the lower drop side tracks - pull towards you before sliding onto the track.



This rubber bumper must be installed prior to operating drop side - it will prevent drop side from falling to the floor

NOTE: Photos A & B are to demonstrate how the drop side should be installed. The photos of the wood components of the crib may differ from the crib purchased and are for reference only.

OPERATING INSTRUCTIONS FOR DROP SIDE.

STAND AT THE MIDDLE OF THE DROP SIDE AND HOLD THE TOP RAIL WITH ONE HAND. RAISE THE DROP SIDE SLIGHTLY TO ENABLE YOU TO RELEASE THE LATCH BY PUSHING ON THE DROP SIDE LOWER RAIL WITH YOUR KNEE. THE DROP SIDE WILL NOW LOWER. RAISE THE DROP SIDE AND IT WILL AUTOMATICALLY LOCK AT THE UPPER POSITION.

ALWAYS MAKE SURE DROP SIDE IS PROPERLY SECURED.

DAY BED

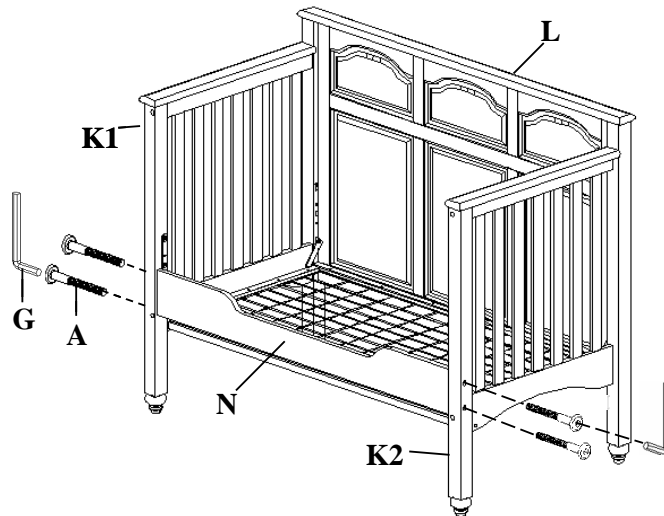

WARNINGS:

- 1. ANY MATTRESS USED IN THIS DAY BED MUST BE AT LEAST 27-1/4" × 51-5/8" (69CM × 131CM) WITH A MINIMUM THICKNESS OF 4" AND NOT EXCEEDING 6" (15CM).**
- 2. THE DAY BED IS INTENDED FOR USE BY A CHILD NOT LESS THAN 15 MONTHS OF AGE AND WHO WEIGHS NO MORE THAN 50LBS (27.7KGS)**

NOTE: WHEN INSERTING SCREWS TURN CLOCKWISE UNTIL TIGHT, THEN LOOSEN 1/2-3/4 OF A TURN, AFTER CRIB IS COMPLETELY ASSEMBLED, RETURN TO EACH SCREW AND TIGHTEN, USE WAX OR SOAP ON ALL SCREWS TO FACILITATE ASSEMBLY.

DAY BED ASSEMBLY INSTRUCTIONS, STARTING FROM CRIB

- STEP 1:** UNSCREW THE RUBBER BUMPER STOP (PART E) FROM THE LOWER DROPSIDE TRACK ON THE LEFT (PART K1) AND RIGHT (PART K2) FRONT POSTS.
- STEP 2:** DETACH THE DROPSIDE (PART M) FROM THE LEFT AND RIGHT POSTS BY SLIDING THE UPPER AND LOWER GUIDES ON EACH END OF THE DROPSIDE DOWN UNTIL THEY ARE BELOW THE UPPER AND LOWER DROPSIDE TRACK. ONCE THE DROPSIDE HITS THE FLOOR, THE GUIDES AND TRACKS CAN BE SEPARATED FROM EACH OTHER.
- STEP 3:** UNSCREW AND DETACH THE LOWER TRACKS FROM THE LEFT AND RIGHT FRONT POSTS.
- STEP 4:** IF MATTRESS SUPPORT (PART P) IS NOT IN THE LOWEST POSITION, UNSCREW MATTRESS SUPPORT BOLTS (PART D) FROM POST AND MOVE IT TO THE LOWEST POSITION.
- NOTE: PLEASE ENSURE THAT THE HEIGHT ADJUSTMENT HOLES BE FILLED WITH SCREWS (D) AFTER THE MATTRESS SUPPORT BEEN MOVED TO THE LOWEST LEVEL, MAKE SURE THAT THESE SCREWS ARE TIGHTLY SECURED.**
- STEP 5:** USING THE WRENCH PROVIDED, ATTACH THE GUARD RAIL (PART N) USING 4 BOLTS (PART A) BETWEEN THE LEFT AND FIGHT FRONT POSTS.

STEP 6: TIGHTEN ALL SCREWS CLOCKWISE.

STARTING FROM SCRATCH:

- STEP 1: FOLLOW STEPS 1 TO 4 OF THE CRIB ASSEMBLY INSTRUCTIONS.**
- STEP 2: FOLLOW STEPS 3 TO 6 FOR THE DAY BED ASSEMBLY INSTRUCTIONS LOCATED ABOVE (STARTING FROM CRIB).**

BED "FULL SIZE"

THIS CRIB CAN BE CHANGED TO A FULL SIZE BED.

USING HEADBOARD (L) TO ATTACH PURCHASED FULL SIZE BED FRAME (NOT PROVIDED) AT THE LOCATION AS DIAGRAM A1 SHOWN.

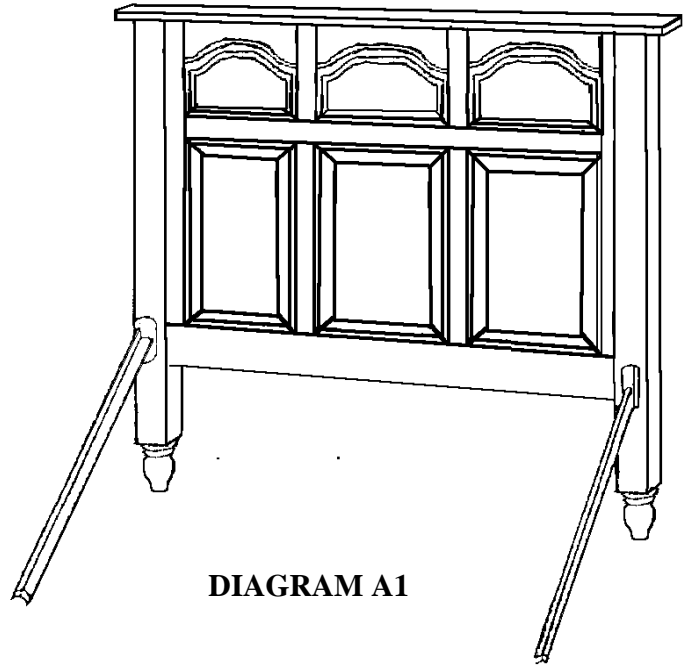

DIAGRAM A1

IMPORTANT: STORE AWAY ALL EXTRA PARTS TO THIS "CRIB". "DAY BED" OR "FULL SIZE HEADBOARD FOOTBOARD" THAT YOU ARE NOT USING FOR POSSIBLE FUTURE USE AS YOU MAY WISH TO CONVERT AGAIN. ALWAYS STORE THE ASSEMBLY DIRECTIONS IN THE POUCH ATTACHED TO THE MATTRESS SUPPORT (PART P).

